

A grayscale photograph of an elevator control panel. The panel features a vertical column of buttons numbered 0 through 5, two directional buttons (up and down), and a yellow emergency stop button at the bottom. Above the buttons is a small rectangular display screen showing a floor indicator. The background shows the interior of an elevator shaft with a grid of ceiling panels and recessed lighting.

Vipal

ITALIAN LIFT FACTORY

CATALOGO ESTETICO
AESTHETIC CATALOGUE



*the **next level**
of vertical
mobility*

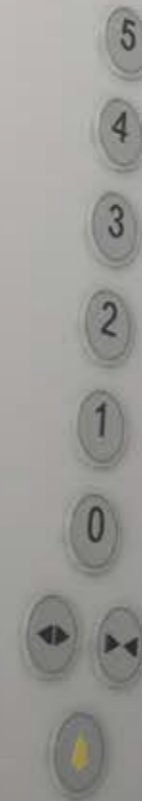

Vipal
ITALIAN LIFT FACTORY

ITALIAN LIFT FACTORY

**Impianti elevatori e strutture
firmate Vipal:**
100% Made in Italy, sicurezza
e innovazione con un'estetica
impeccabile.

Vipal Elevators and Metal Shaft:
100% Made in Italy,
combining safety and
innovation with outstanding
design.





Indice *Index*

Skin 8

Linen
Cotton
Beige
White
Similinox

Wood 22



Acero
Carpino
Olmo
Perera
Shabby
White
Beige
Gray

Inox 38

Satin
Trama

Porte Doors 42

Accessori Accessories 44

Rifiniture Finishes 46

Pre-Configurazioni Pre-Settings 48

1 Z

I

K

S

Linen



Cotton



Beige



White



Similnox





Linen 8019
Lunar Antracite



Linen 7047
Vintage Zinc



Cotton 7006
Pine White



Cotton 7047
Lunar Gray



Beige 1013
Pine White



Beige 1019
Marble Beige

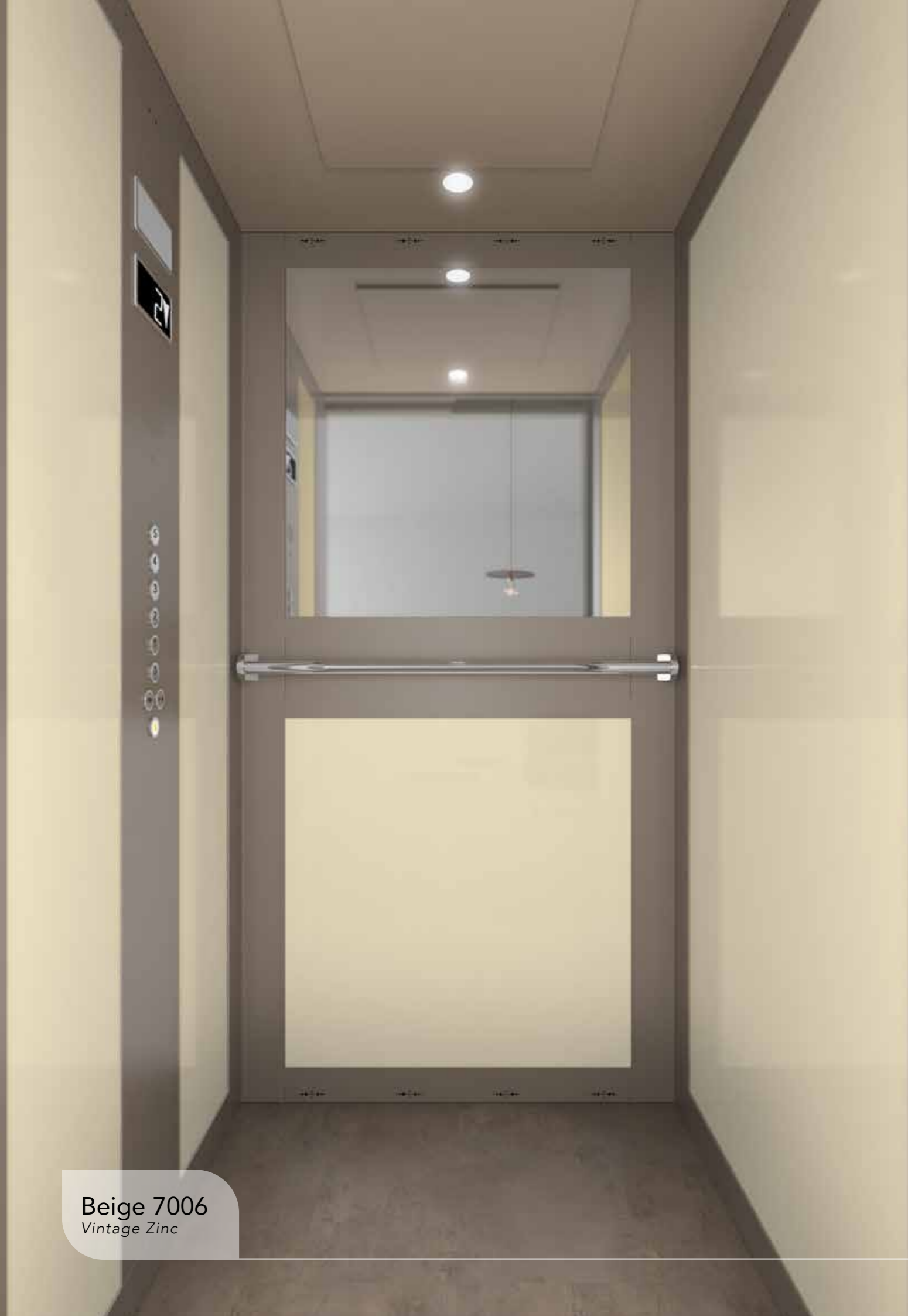

Beige 7006
Vintage Zinc



White 1019
Pine White



White 9016
Lunar Gray



White 7006
Fossil Brown



Similnox 7047
Lunar Gray



Similnox 7047
Lunar Antracite

2D OO OO W

Acero



Carpino



Olmo



Perera



Shabby



*White
Beige
Grey*





Acero 1013
Marble Beige

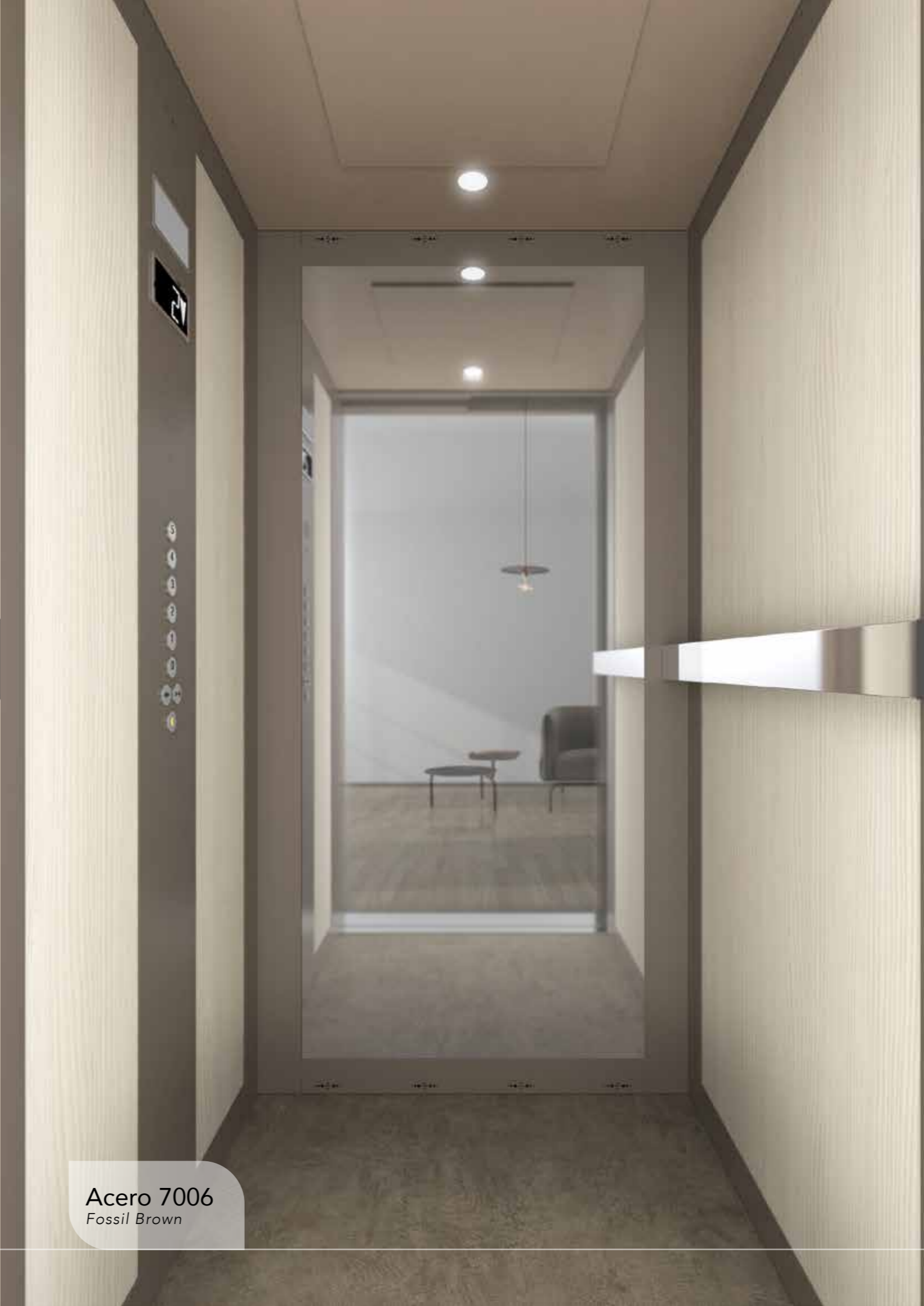

Acero 7006
Fossil Brown



NEW

Carpino 7047
Vintage Zinc



NEW

Carpino 8019
Lunar Antracite



Olmo 1013
Marble Beige



Olmo 1019
Lunar Antracite

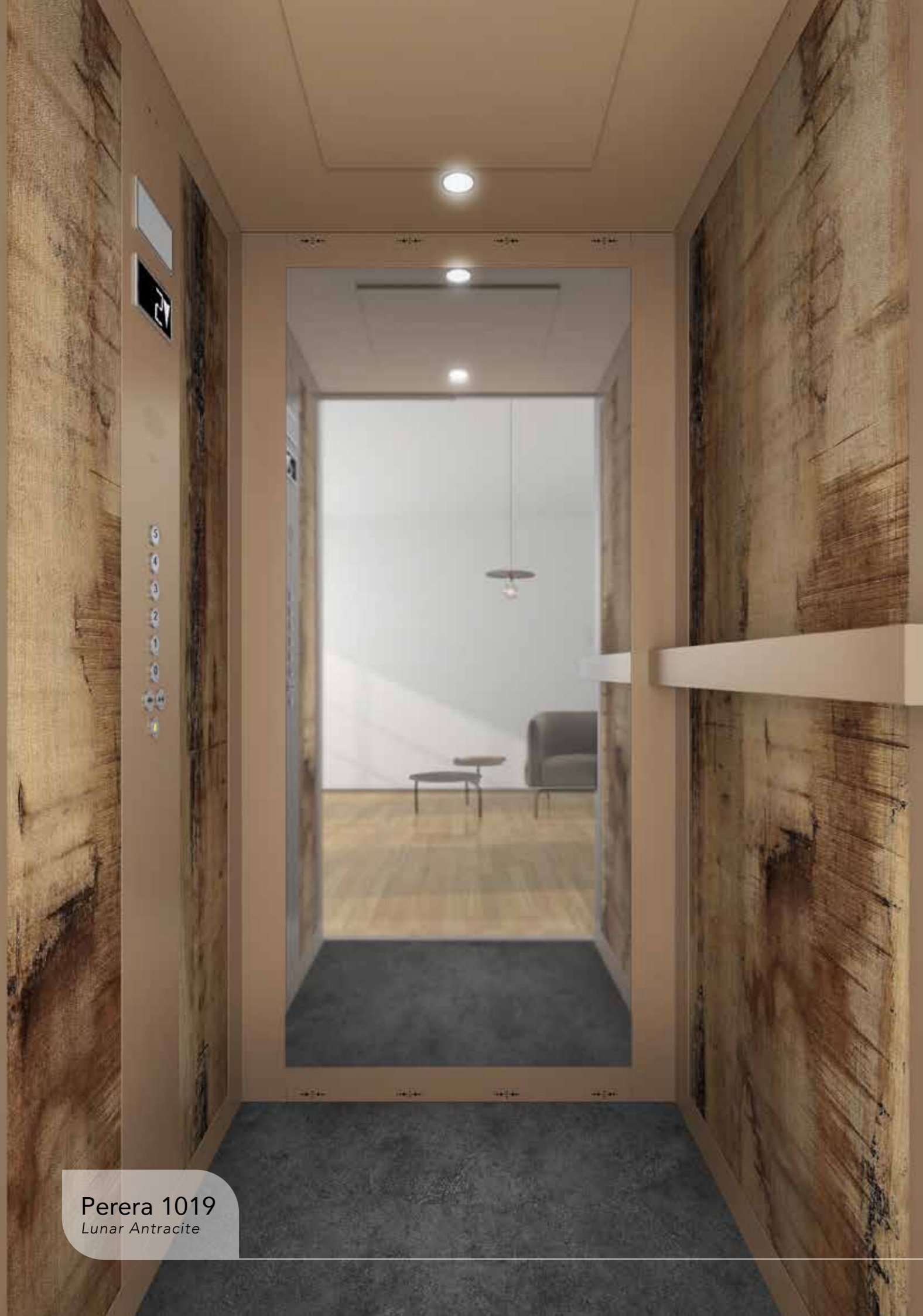

Perera 1019
Lunar Antracite

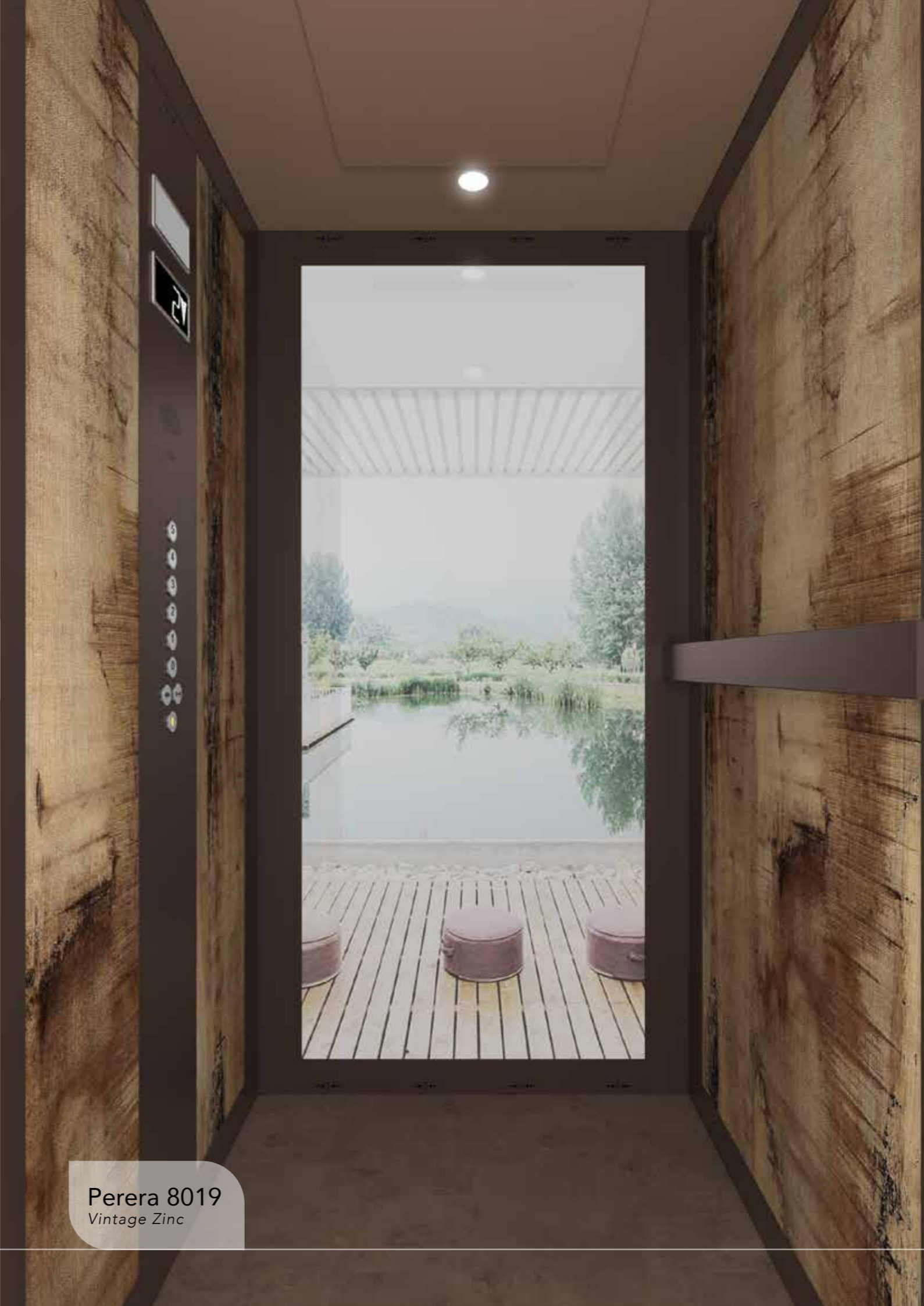

Perera 8019
Vintage Zinc



Shabby Inox
Lunar Gray



Shabby 9016
Vintage Zinc



White 9016
Lunar Antracite



Gray 7047
Lunar Gray



Beige 1013
Pine White



Beige 7006
Pine White

3X

O

N

I

Satin



Trama





Steel Satin
Vintage Zinc



Steel Trama
Pine White



PORTE DOORS

PORTE A SOFFIETTO / AUTOMATIC FOLDING DOORS



CIECA
BLIND
(PS-01)



2 VETRI
2 GLASS
(PS-02)



4 VETRI
4 GLASS
(PS-03)



8 VETRI
8 GLASS
(PS-04)

PORTE A BATTENTE / SWING DOORS



ONICE
(PB-01)



GIADA
(PB-02)



ZAFFIRO
(PB-03)



CRISTALLO
(PB-04)



ALLUMINIO
(PB-05)

PORTE AUTOMATICHE / SLIDING DOORS: T2 - T3 - 2AC - 4AC



CIECA
BLIND
(PA-01)



VETRO TOTALE
FULL GLASS
(PA-02)



VETRO INTELAIATO
GLASS FRAME
(PA-03)



TAGLIAFUOCO
FIRE RESISTANT
(PA-04)

ACCESSORI / ACCESSORIES

CORRIMANO / HANDRAIL

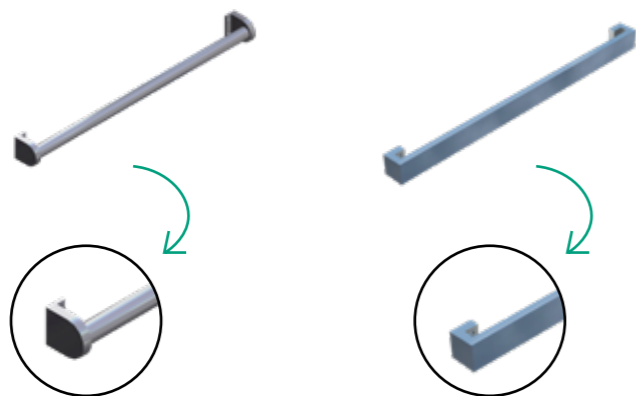

ROUND
(C-01)

SQUARE INOX
(C-02)

SPECCHI E VETRI PANORAMICI / GLASS AND PANORAMIC PANEL

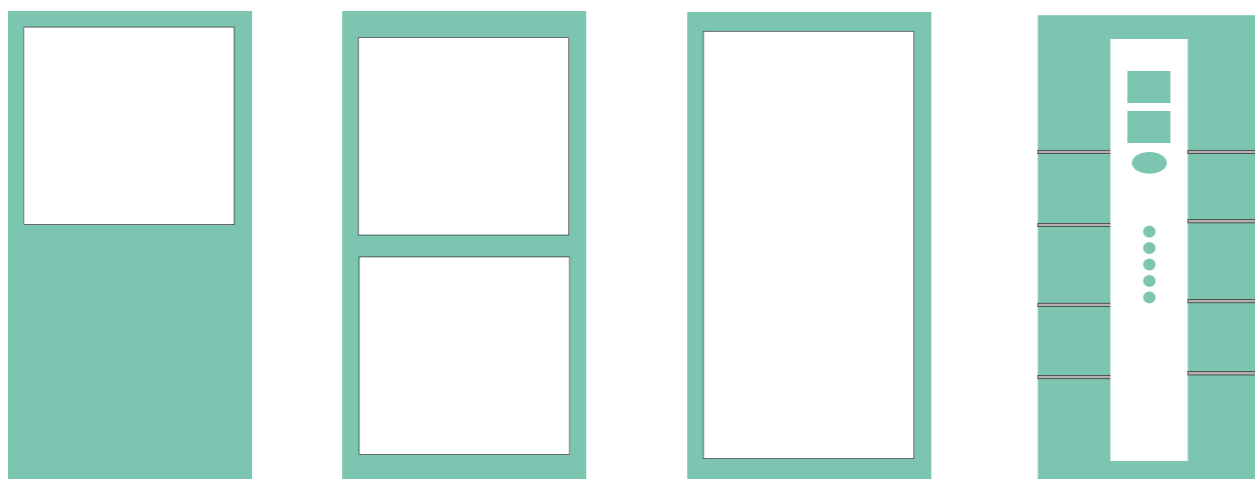

METÀ PARETE
HALF PANEL
(SV-01)

PARETE INTERA CON FASCIA
FULL PANEL WITH STRIP
(SV-02)

PARETE INTERA
FULL PANEL
(SV-03)

LISTELLI DECORATIVI
HORIZONTAL FINISHES SLATS
(SV-04)

ILLUMINAZIONE LED / LED LIGHTING



LINE
(L-01)

KIRI
(L-02)

TWIN
(L-03)

DIAMOND
(L-04)

SQUARE
(L-05)

DISPLAY



BLUE TRICOLOR
(DY-01)

BLACK TRICOLOR
(DY-02)

TF 7"
(DY-03)

BLUE ICARO
(DY-04)

BLACK ICARO
(DY-05)

BOTTONIERE / PUSHBUTTON PANELS

BOTTONIERE VERTICALI / VERTICAL CAR OPERATING PANEL (V-COP)



TYPE 1 - INOX
(BY-01)

TYPE 1 - COLOUR / SELEZIONE RAL - RAL SELECTION
(BY-02)

BOTTONIERE ORIZZONTALI / HORIZONTAL CAR OPERATING PANEL (H-COP)



TYPE 2 - INOX
(BH-01)

TYPE 2 - COLOUR / SELEZIONE RAL - RAL SELECTION
(BH-02)



FLAT
(BP-01)

REGULAR
(BP-02)

VELA
(BP-03)

BUTTON ON FRAME
(BP-04)

BOTTONIERE DI PIANO
LANDING OPERATING PANEL (LOP)

PULSANTI / BUTTONS



SILVER RED
(P-01)

SQUARE RED
(P-02)

BLACK
(P-03)

GOLD
(P-04)

AKILLE VANDAL RESISTANT
(P-05)

ACCESSORI PREFERENZIALI / PREFERRED ACCESSORIES



I-BUTTON
(K-01)

KI-KEY
(K-02)

MECHANICAL LOCK FOR SWING DOOR
(ML-01)

RIFINITURE

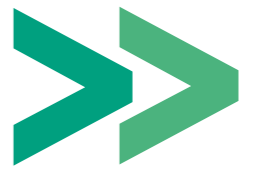

SKIN



WOOD



INOX

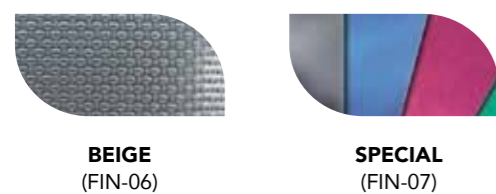

VIPAL SELECTION



FINISHES

SELEZIONE RAL / RAL SELECTION

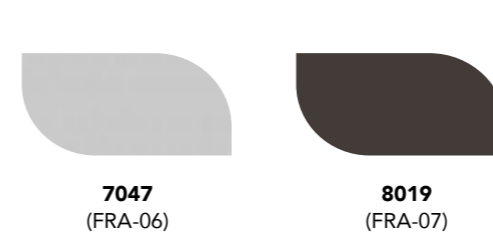
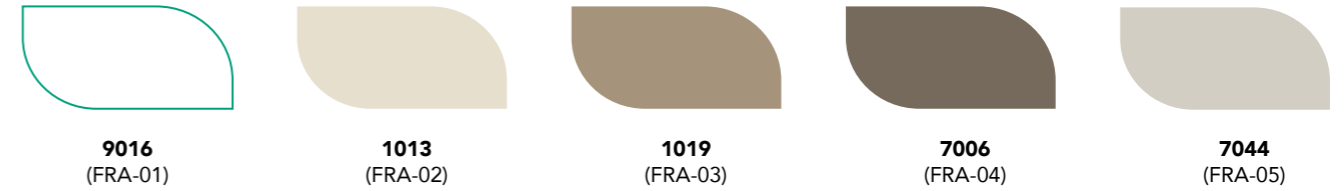

RAL SU RICHIESTA
RAL ON REQUEST



NEW MATT TEXTURE

RIVESTIMENTO PAVIMENTI / FLOOR COVERING

PAVIMENTI IN PVC / PVC FLOORING



PAVIMENTI IN AGGLOMERATO / AGGLOMERATE FLOORING

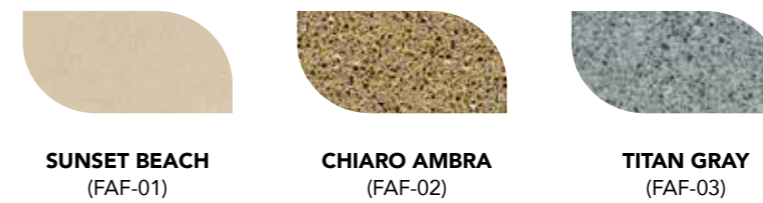

PRE-CONFIGURAZIONI

PRE - SETTINGS

LEGENDA

✓ STANDARD

\$ OPZIONALE / OPTIONAL

(E) ASCENSORI / ELEVATOR

(HL) ASCENSORI DOMESTICI / HOME LIFT

(-) NON PREVISTO - NOT AVAILABLE

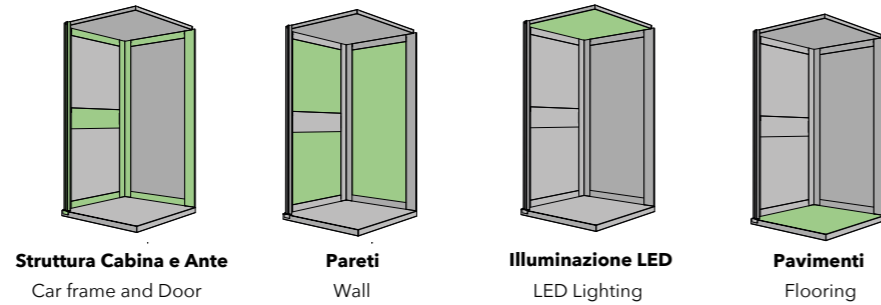

	SKIN					WOOD							INOX		
	WHITE	BEIGE	LINEN	COTTON	SIMIL INOX	SHABBY	CARPINO	ACERO	OLMO	PERERA	GREY	WHITE	BEIGE	SATIN	TRAMA
Struttura Cabine e Ante - Car frame and door															
RAL 9016	✓	-	-	-	-	✓	-	-	-	-	-	✓	-	-	-
RAL 7047	✓	-	-	-	-	✓	-	-	-	-	-	✓	-	-	-
RAL 7006	✓	✓	✓	✓	✓	✓	✓	✓	✓	✓	✓	✓	✓	✓	✓
RAL 7044	-	-	-	-	-	-	-	-	-	-	-	-	-	-	-
RAL 1013	-	✓	-	-	-	-	-	-	-	-	-	-	✓	-	-
RAL 1019	✓	✓	✓	✓	✓	✓	✓	✓	✓	✓	✓	✓	✓	✓	✓
RAL 8019	-	-	-	-	-	-	-	-	-	-	-	-	-	-	-
Inox Satin - SB	\$	\$	\$	\$	\$	\$	\$	\$	\$	\$	\$	\$	\$	✓	✓
Inox Semipolished - BA	\$	\$	\$	\$	\$	\$	\$	\$	\$	\$	\$	\$	\$	✓	✓
Inox Mirror	\$	\$	\$	\$	\$	\$	\$	\$	\$	\$	\$	\$	\$	✓	✓
Pareti - Wall															
Wood	-	-	-	-	-	✓	✓	✓	✓	✓	✓	✓	✓	-	-
Skinplate	✓	✓	✓	✓	✓	✓	✓	✓	✓	✓	✓	✓	✓	-	-
Stone	-	-	-	-	-	-	-	-	-	-	-	-	-	✓	✓
Inox Satin-SB	-	-	-	-	-	-	-	-	-	-	-	-	-	✓	✓
Inox Semipolished-BA	-	-	-	-	-	-	-	-	-	-	-	-	-	✓	✓
Inox Rigidizzato Trama / Patterned	-	-	-	-	-	-	-	-	-	-	-	-	-	\$	✓
Inox Rigidizzato Dama / Patterned	-	-	-	-	-	-	-	-	-	-	-	-	-	✓	✓
Inox Rigidizzato Lino / Patterned	-	-	-	-	-	-	-	-	-	-	-	-	-	✓	✓
Listelli decorativi / Slats	-	-	-	-	-	\$	\$	\$	\$	\$	\$	\$	\$	✓	✓
Illuminazione LED - LED Lighting															
Line (E)	\$	\$	\$	\$	\$	\$	\$	\$	\$	\$	\$	\$	\$	\$	\$
Kiri (E)	✓	✓	✓	✓	✓	✓	✓	✓	✓	✓	✓	✓	✓	✓	✓
Twin (HL)	✓	✓	✓	✓	✓	✓	✓	✓	✓	✓	✓	✓	✓	✓	✓
Diamond (HL)	\$	\$	\$	\$	\$	\$	\$	\$	\$	\$	\$	\$	\$	\$	\$
Square (HL)	\$	\$	\$	\$	\$	\$	\$	\$	\$	\$	\$	\$	\$	\$	\$
Pavimenti PVC - PVC Flooring															
Marble Beige	✓	✓	✓	✓	-	-	-	✓	✓	-	-	✓	✓	✓	✓
Marble Gray	✓	-	✓	✓	✓	-	-	✓	✓	-	-	✓	✓	✓	✓
Lunar Antracite	-	-	✓	✓	✓	-	-	✓	✓	-	-	✓	✓	✓	✓
Lunar Gray	✓	-	✓	✓	✓	✓	-	✓	✓	-	-	✓	✓	✓	✓
Fossil Brown	✓	✓	✓	✓	-	-	✓	✓	✓	-	-	✓	✓	✓	✓
Pine White (PVC modular)	\$	\$	\$	\$	\$	-	-	-	-	-	\$	\$	\$	\$	\$
Vintage Zinc (PVC modular)	\$	\$	\$	\$	\$	\$	\$	-	-	\$	-	\$	\$	\$	\$
Pavimenti in granito - Granite Flooring															
Sunset Beach	\$	\$	-	\$	-	-	-	\$	\$	\$	-	\$	\$	\$	\$
Chiaro Ambra	\$	\$	-	\$	-	-	-	\$	\$	\$	-	\$	\$	\$	\$
Titan Gray	-	-	\$	-	\$	\$	\$	-	-	-	\$	-	-	\$	\$
Escluso con pred. 20 mm / Excluded with 20mm pred.															
	\$	\$	\$	\$	\$	\$	\$	\$	\$	\$	\$	\$	\$	\$	\$

INFORMAZIONI TECNICHE - TECHNICAL INFORMATION:

WOOD: Pannelli in nobilitato bifacciale ignifugo classe 0 / Fireproof bifacial chipboard melamine panels - Class 0

SKIN: Pannelli sandwich in lamiera plastificata ignifughi classe 0 / Fireproof Skinplate sandwich panels - Class 0

INOX: Pannelli sandwich in lamiera di acciaio inox ignifughi classe 0 / Fireproof Inox sandwich panels - Class 0

PVC: Vinyl eterogeneo compatto - Trattamento superficiale TopClean™ PUR per eccellente resistenza all'improntabilità, all'abrasione e ai graffi
Heterogeneous and compact Vinyl - TopClean™ PUR surface treatment: extreme resistance to indentation, abrasion and tearing.

VERNICIATURA / PAINTING: Tutte le nostre verniciature sono in polvere poliestere texture opache rif.to ISO 7253 (Cert. Ist. Masini n°1812-2007)
All our painting are in matt textured powder ISO 7253 (Inst. Masini Cert. n°1812-2007)

Vipal
ITALIAN LIFT FACTORY

Tutti i diritti sono riservati. È vietata la riproduzione o divulgazione, anche parziale, del presente documento senza il consenso scritto della Vipal S.p.A.

Tutti i prodotti e le immagini sono inserite a scopo illustrativo e possono subire modifiche senza preavviso.

All rights reserved. Unauthorised reproduction or disclosure of all or part of this document, without Vipal Spa's written consent is prohibited.

All products and pictures shown are for illustration purposes only and they may be changed without notice.

PR - FESR 2021-2027 - Priorità 1 - OS 1.3 - Azione 1.3.2 - Sostegno all'internazionalizzazione delle PMI - Avviso pubblico per la presentazione di progetti di internazionalizzazione delle PMI mediante la partecipazione a fiere internazionali che si svolgono dal 1 aprile 2025 al 31 marzo 2026

PR - ERDF 2021-2027 - Priority 1 - OS 1.3 - Action 1.3.2 - Support for the internationalization of SMEs - Public notice for the presentation of internationalization projects of SMEs through participation in international fairs which they take place from 1st April 2025 to 31 March 2026



PROGETTO REALIZZATO GRAZIE AI FONDI EUROPEI DELLA REGIONE UMBRIA



Commissario Straordinario
Ricostruzione Sisma 2016
Presidenza del Consiglio dei Ministri

*the next level
of vertical
mobility*

DISTRIBUTORE CERTIFICATO
CERTIFICATED DISTRIBUTOR

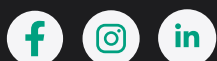
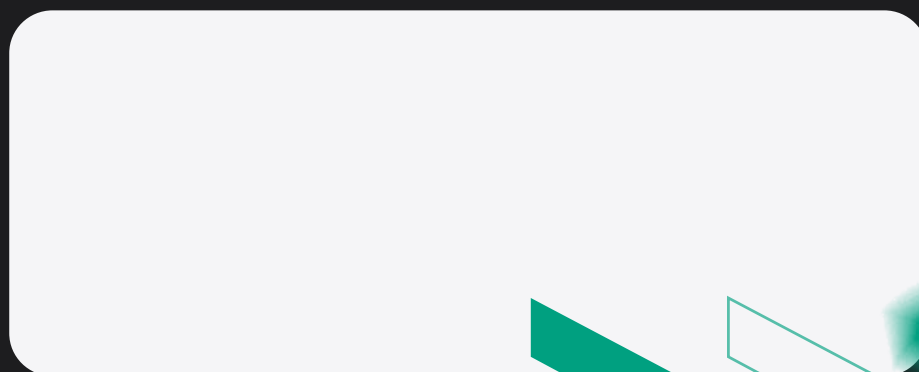

+39 0744 78 07 27

INFO@VIPALSPA.COM

VIA LUIGI EINAUDI, 1 - 05034 FERENTILLO (TERNI), ITALY



2025 REV. 15