

A grayscale photograph of an elevator control panel. The panel features a vertical column of buttons numbered 0 through 5, two directional buttons (up and down), and a yellow emergency stop button at the bottom. Above the buttons is a small rectangular display screen showing a floor indicator. The background shows the interior of an elevator shaft with a grid of panels and ceiling lights.

# Vipal

ITALIAN LIFT FACTORY

CATALOGO ESTETICO  
AESTHETIC CATALOGUE



*the **next level**  
of vertical  
mobility*

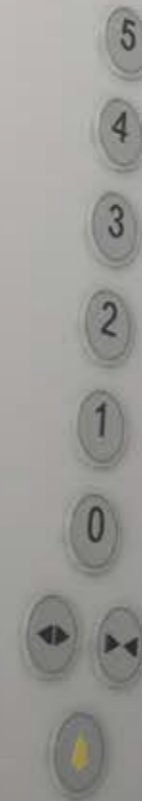

**Vipal**  
ITALIAN LIFT FACTORY

# ITALIAN LIFT FACTORY

**Impianti elevatori e strutture  
firmate Vipal:**  
**100% Made in Italy**, sicurezza  
e innovazione con un'estetica  
impeccabile.

**Vipal Elevators and Metal Shaft:**  
**100% Made in Italy**,  
combining safety and  
innovation with outstanding  
design.





# Indice *Index*

**Skin** 8

Linen  
Cotton  
Beige  
White  
Similinox

**Wood** 22



Acero  
Carpino  
Olmo  
Perera  
Shabby  
White  
Beige  
Gray

**Inox** 38

Satin  
Trama

**Porte Doors** 42

**Accessori Accessories** 44

**Rifiniture Finishes** 46

**Pre-Configurazioni Pre-Settings** 48

1 Z

L

K

S

*Linen*



*Cotton*



*Beige*



*White*



*Similnox*





Linen 8019  
Lunar Antracite



Linen 7047  
Vintage Zinc



**Cotton 7006**  
*Pine White*



**Cotton 7047**  
*Lunar Gray*



**Beige 1013**  
*Pine White*



**Beige 1019**  
*Marble Beige*

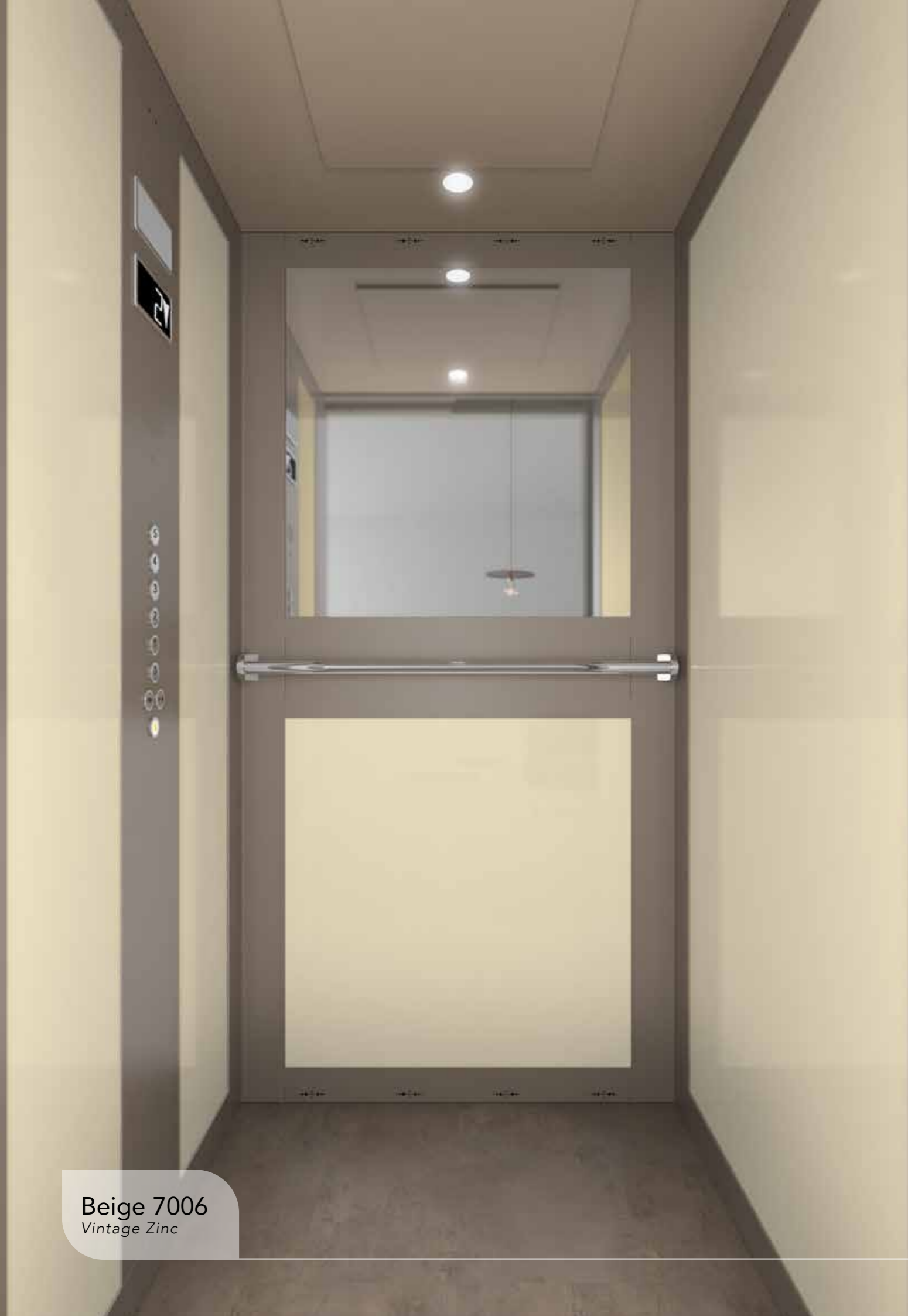

**Beige 7006**  
*Vintage Zinc*



**White 1019**  
*Pine White*



White 9016  
Lunar Gray



White 7006  
Fossil Brown



**Similnox 7047**  
*Lunar Gray*



**Similnox 7047**  
*Lunar Antracite*

# 2020 W

*Acero*



*Carpino*



*Olmo*



*Perera*



*Shabby*



*White  
Beige  
Grey*





**Acero 1013**  
Marble Beige

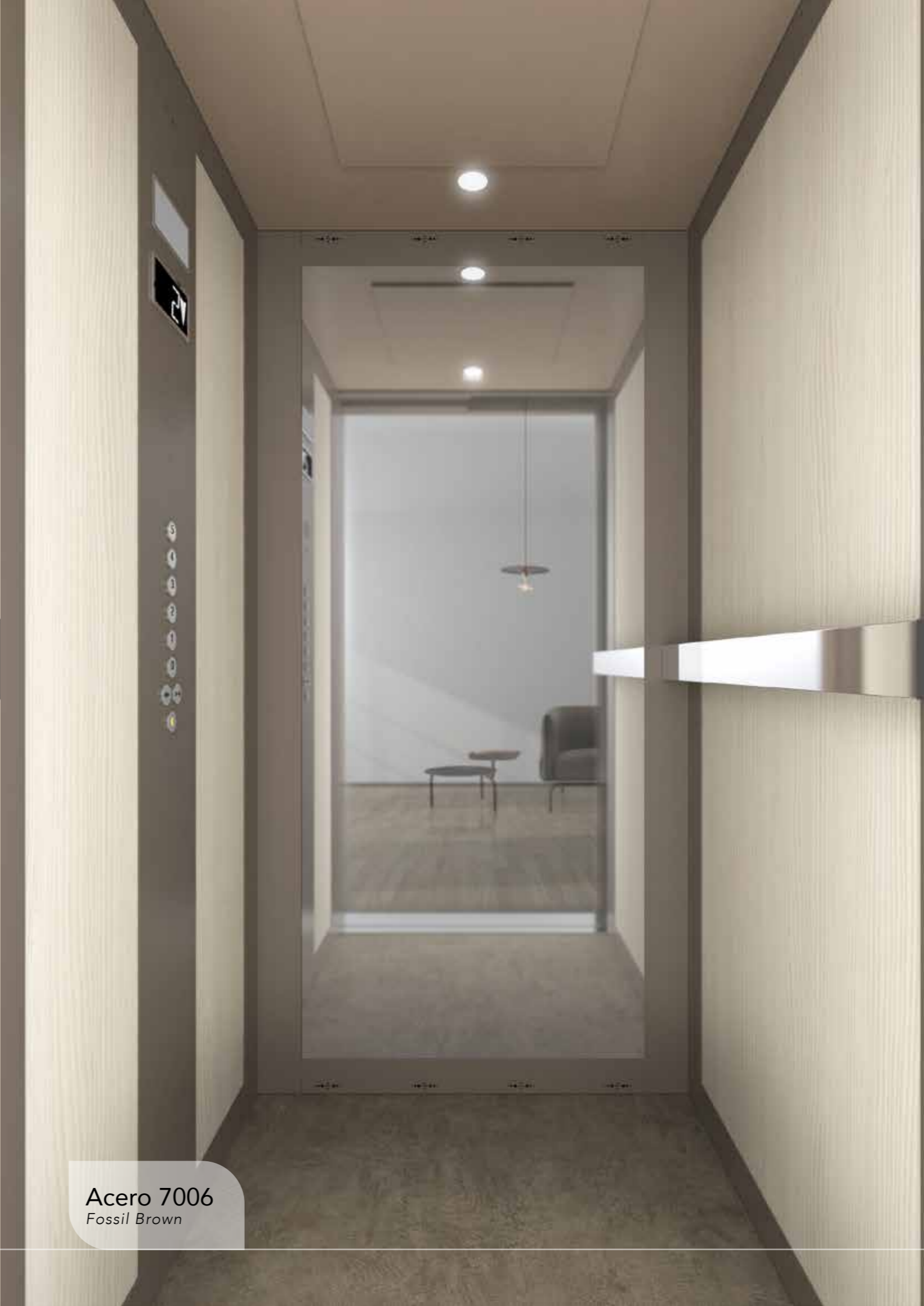

**Acero 7006**  
Fossil Brown



NEW

Carpino 7047  
Vintage Zinc



NEW

Carpino 8019  
Lunar Antracite



**Olmo 1013**  
Marble Beige



**Olmo 1019**  
Lunar Antracite

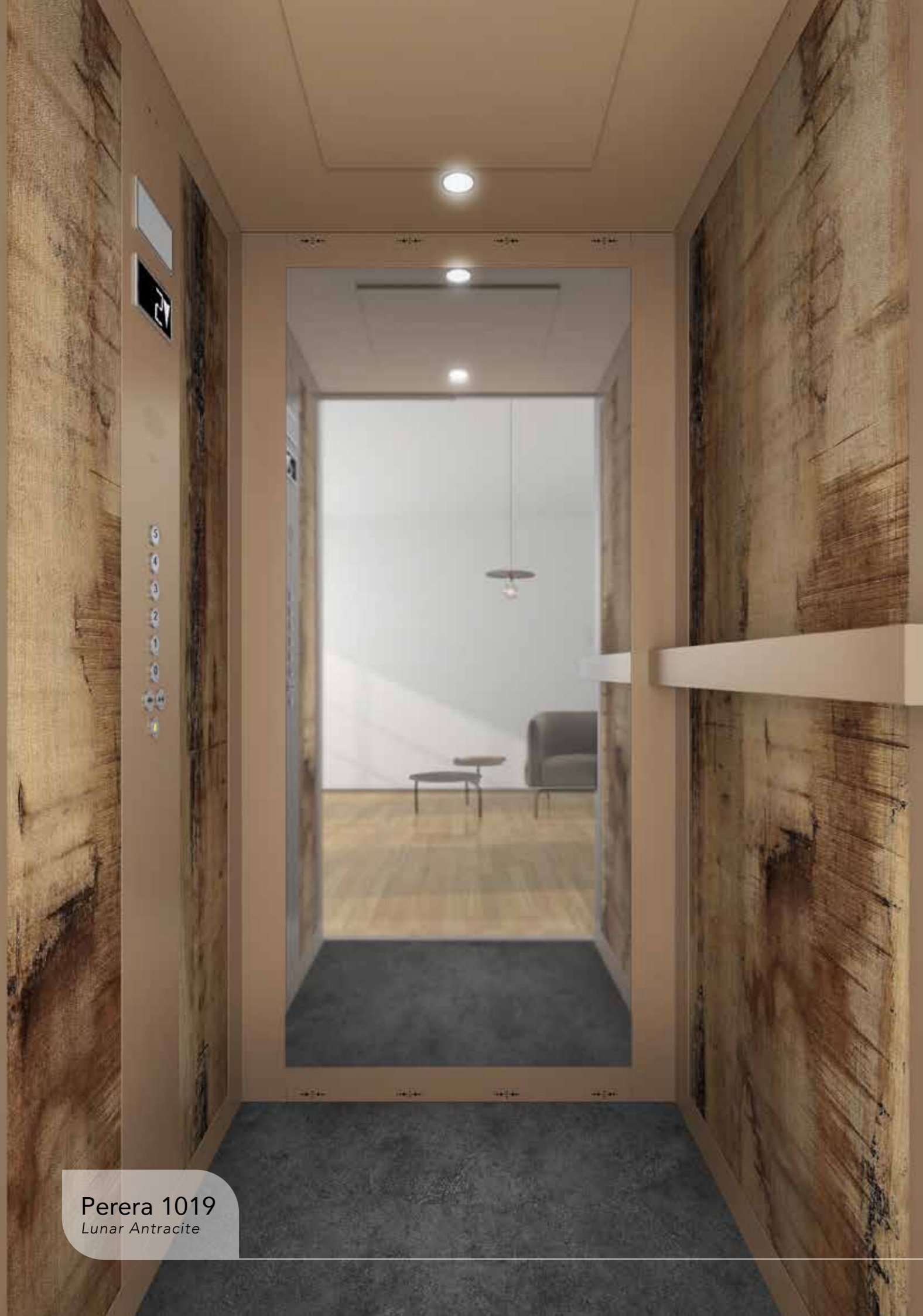

Perera 1019  
Lunar Antracite

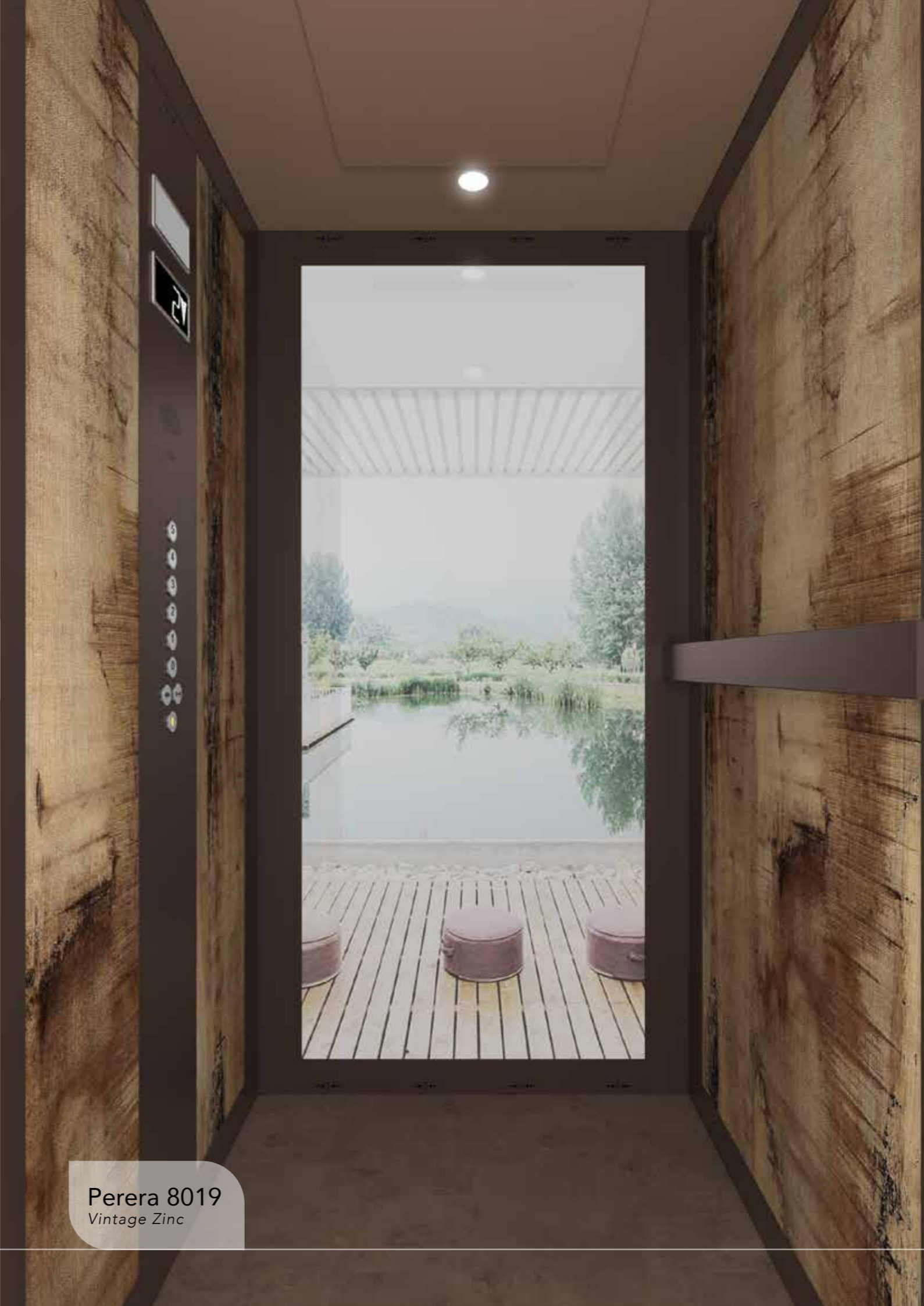

Perera 8019  
Vintage Zinc



**Shabby Inox**  
Lunar Gray



**Shabby 9019**  
Vintage Zinc



**White 9016**  
*Lunar Antracite*



**Gray 7047**  
*Lunar Gray*



**Beige 1013**  
*Pine White*



**Beige 7006**  
*Pine White*

3X

O

N

I

*Satin*



*Trama*





**Steel Satin**  
*Vintage Zinc*



**Steel Trama**  
*Pine White*



# PORTE DOORS

## PORTE A SOFFIETTO / AUTOMATIC FOLDING DOORS



**CIECA**  
BLIND  
(PS-01)



**2 VETRI**  
2 GLASS  
(PS-02)



**4 VETRI**  
4 GLASS  
(PS-03)



**8 VETRI**  
8 GLASS  
(PS-04)

## PORTE A BATTENTE / SWING DOORS



**ONICE**  
(PB-01)



**GIADA**  
(PB-02)



**ZAFFIRO**  
(PB-03)



**CRISTALLO**  
(PB-04)



**ALLUMINIO**  
(PB-05)

## PORTE AUTOMATICHE / SLIDING DOORS: T2 - T3 - 2AC - 4AC



**CIECA**  
BLIND  
(PA-01)



**VETRO TOTALE**  
FULL GLASS  
(PA-02)



**VETRO INTELAIATO**  
GLASS FRAME  
(PA-03)



**TAGLIAFUOCO**  
FIRE RESISTANT  
(PA-04)

# ACCESSORI / ACCESSORIES

## CORRIMANO / HANDRAIL

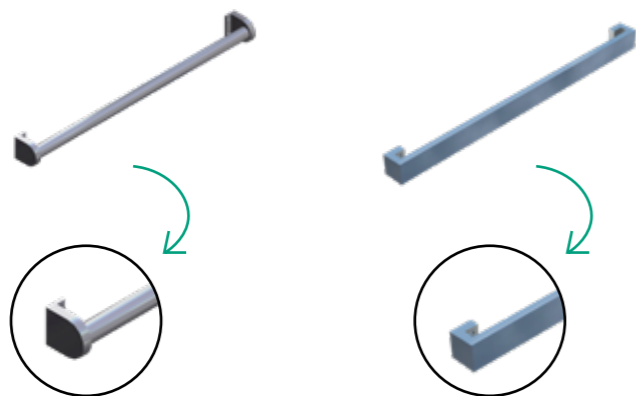

**ROUND**  
(C-01)

**SQUARE INOX**  
(C-02)

## SPECCHI E VETRI PANORAMICI / GLASS AND PANORAMIC PANEL

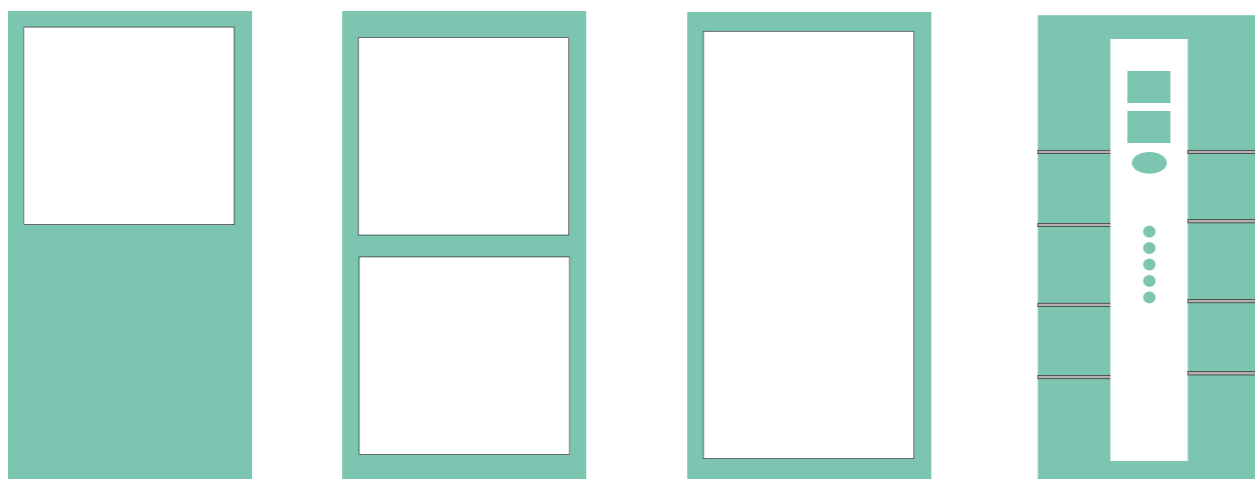

**METÀ PARETE**  
HALF PANEL  
(SV-01)

**PARETE INTERA CON FASCIA**  
FULL PANEL WITH STRIP  
(SV-02)

**PARETE INTERA**  
FULL PANEL  
(SV-03)

**LISTELLI DECORATIVI**  
HORIZONTAL FINISHES SLATS  
(SV-04)

## ILLUMINAZIONE LED / LED LIGHTING



**LINE**  
(L-01)

**KIRI**  
(L-02)

**TWIN**  
(L-03)

**DIAMOND**  
(L-04)

**SQUARE**  
(L-05)

## DISPLAY



**BLUE TRICOLOR**  
(DY-01)

**BLACK TRICOLOR**  
(DY-02)

**TF 7"**  
(DY-03)

**BLUE ICARO**  
(DY-04)

**BLACK ICARO**  
(DY-05)

## BOTTONIERE / PUSHBUTTON PANELS

### BOTTONIERE VERTICALI / VERTICAL CAR OPERATING PANEL (V-COP)



TYPE 1 - INOX  
(BY-01)

TYPE 1 - COLOUR / SELEZIONE RAL - RAL SELECTION  
(BY-02)

### BOTTONIERE ORIZZONTALI / HORIZONTAL CAR OPERATING PANEL (H-COP)



TYPE 2 - INOX  
(BH-01)

TYPE 2 - COLOUR / SELEZIONE RAL - RAL SELECTION  
(BH-02)

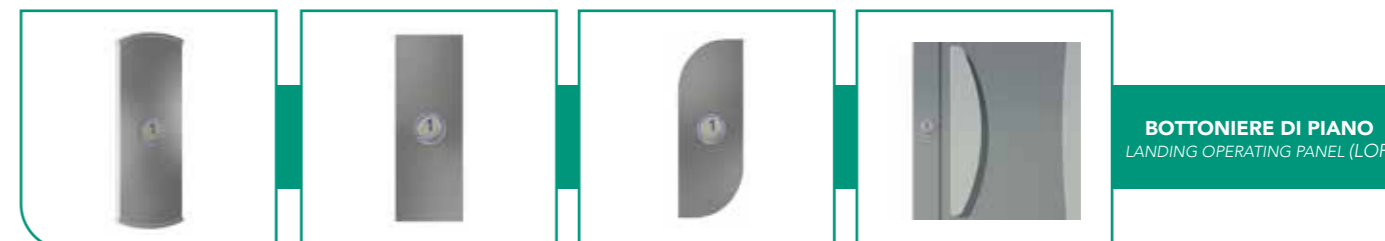

**FLAT**  
(BP-01)

**REGULAR**  
(BP-02)

**VELA**  
(BP-03)

**BUTTON ON FRAME**  
(BP-04)

**BOTTONIERE DI PIANO**  
LANDING OPERATING PANEL (LOP)

## PULSANTI / BUTTONS



**SILVER RED**  
(P-01)

**SQUARE RED**  
(P-02)

**BLACK**  
(P-03)

**GOLD**  
(P-04)

**AKILLE VANDAL RESISTANT**  
(P-05)

## ACCESSORI PREFERENZIALI / PREFERRED ACCESSORIES



**I-BUTTON**  
(K-01)

**KI-KEY**  
(K-02)

**MECHANICAL LOCK FOR SWING DOOR**  
(ML-01)

# RIFINITURE

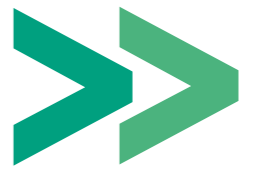

## SKIN



## WOOD



## INOX

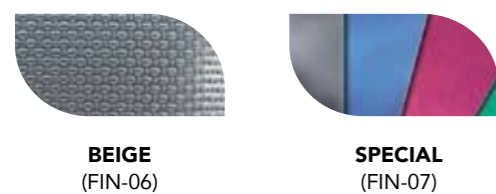

## VIPAL SELECTION



# FINISHES

## SELEZIONE RAL / RAL SELECTION

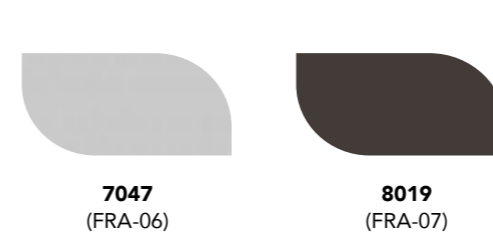
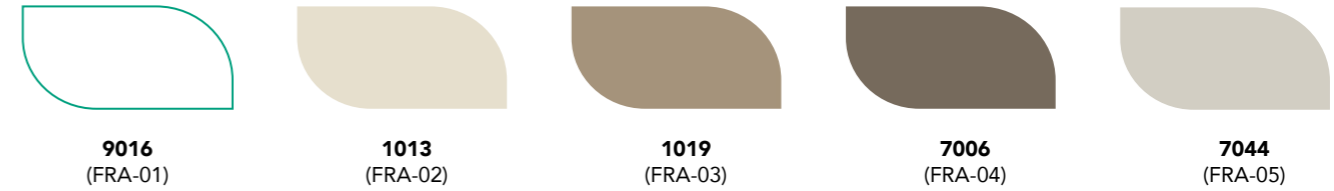

RAL SU RICHIESTA  
RAL ON REQUEST



NEW MATT TEXTURE

## RIVESTIMENTO PAVIMENTI / FLOOR COVERING

### PAVIMENTI IN PVC / PVC FLOORING



### PAVIMENTI IN AGGLOMERATO / AGGLOMERATE FLOORING

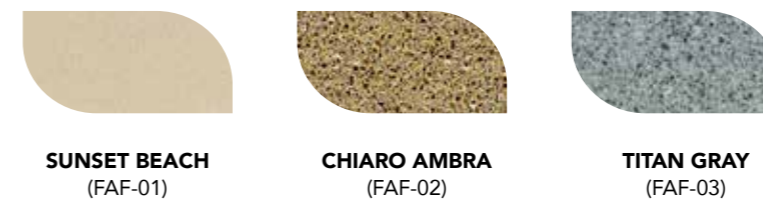

# PRE-CONFIGURAZIONI

## PRE - SETTINGS

### LEGENDA

✓ STANDARD

\$ OPZIONALE / OPTIONAL

(E) ASCENSORI / ELEVATOR

(HL) ASCENSORI DOMESTICI / HOME LIFT

(-) NON PREVISTO - NOT AVAILABLE

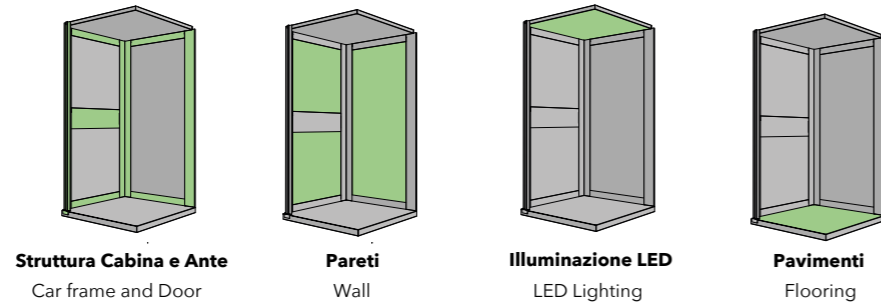

**Struttura Cabina e Ante**  
Car frame and Door

**Pareti**  
Wall

**Illuminazione LED**  
LED Lighting

**Pavimenti**  
Flooring

	SKIN						WOOD						INOX		
	WHITE	BEIGE	LINEN	COTTON	SIMIL INOX	SHABBY	CARPINO	ACERO	OLMO	PERERA	GREY	WHITE	BEIGE	SATIN	TRAMA
<b>Struttura Cabine e Ante - Car frame and door</b>															
RAL 9016	✓	-	-	-	-	✓	-	-	-	-	-	✓	-	-	-
RAL 7047	✓	-	-	-	-	✓	-	-	-	-	-	✓	-	-	-
RAL 7006	✓	✓	✓	✓	✓	✓	✓	✓	✓	✓	✓	✓	✓	✓	✓
RAL 7044	-	-	-	-	-	-	-	-	-	-	-	-	-	-	-
RAL 1013	-	✓	-	-	-	-	-	-	-	-	-	-	✓	-	-
RAL 1019	✓	✓	✓	✓	✓	✓	✓	✓	✓	✓	✓	✓	✓	✓	✓
RAL 8019	-	-	-	-	-	-	-	-	-	-	-	-	-	-	-
Inox Satin - SB	\$	\$	\$	\$	\$	\$	\$	\$	\$	\$	\$	\$	\$	✓	✓
Inox Semipolished - BA	\$	\$	\$	\$	\$	\$	\$	\$	\$	\$	\$	\$	\$	✓	✓
Inox Mirror	\$	\$	\$	\$	\$	\$	\$	\$	\$	\$	\$	\$	\$	✓	✓
<b>Pareti - Wall</b>															
Wood	-	-	-	-	-	✓	✓	✓	✓	✓	✓	✓	✓	-	-
Skinplate	✓	✓	✓	✓	✓	✓	✓	✓	✓	✓	✓	✓	✓	-	-
Stone	-	-	-	-	-	-	-	-	-	-	-	-	-	✓	-
Inox Satin-SB	-	-	-	-	-	-	-	-	-	-	-	-	-	✓	-
Inox Semipolished-BA	-	-	-	-	-	-	-	-	-	-	-	-	-	✓	-
Inox Rigidizzato Trama / Patterned	-	-	-	-	-	-	-	-	-	-	-	-	-	✓	✓
Inox Rigidizzato Dama / Patterned	-	-	-	-	-	-	-	-	-	-	-	-	-	✓	✓
Inox Rigidizzato Lino / Patterned	-	-	-	-	-	-	-	-	-	-	-	-	-	✓	✓
Listelli decorativi / Slats	-	-	-	-	-	\$	\$	\$	\$	\$	\$	\$	\$	-	✓
<b>Illuminazione LED - LED Lighting</b>															
Line (E)	\$	\$	\$	\$	\$	\$	\$	\$	\$	\$	\$	\$	\$	\$	\$
Kiri (E)	✓	✓	✓	✓	✓	✓	✓	✓	✓	✓	✓	✓	✓	✓	✓
Twin (HL)	✓	✓	✓	✓	✓	✓	✓	✓	✓	✓	✓	✓	✓	✓	✓
Diamond (HL)	\$	\$	\$	\$	\$	\$	\$	\$	\$	\$	\$	\$	\$	\$	\$
Square (HL)	\$	\$	\$	\$	\$	\$	\$	\$	\$	\$	\$	\$	\$	\$	\$
<b>Pavimenti PVC - PVC Flooring</b>															
Marble Beige	✓	✓	✓	✓	-	-	-	✓	✓	-	-	✓	✓	✓	✓
Marble Gray	✓	-	✓	✓	✓	-	-	✓	✓	-	-	✓	✓	✓	✓
Lunar Antracite	-	-	✓	✓	✓	-	-	✓	✓	-	-	✓	✓	✓	✓
Lunar Gray	✓	-	✓	✓	✓	-	-	✓	✓	-	-	✓	✓	✓	✓
Fossil Brown	✓	✓	✓	✓	-	-	✓	✓	✓	-	-	✓	✓	✓	✓
Pine White (PVC modular)	\$	\$	\$	\$	\$	-	-	-	-	-	\$	\$	\$	\$	\$
Vintage Zinc (PVC modular)	\$	\$	\$	\$	\$	\$	\$	-	-	\$	-	\$	\$	\$	\$
<b>Pavimenti in granito - Granite Flooring</b>															
Sunset Beach	\$	\$	-	\$	-	-	-	\$	\$	\$	-	\$	\$	\$	\$
Chiaro Ambra	\$	\$	-	\$	-	-	-	\$	\$	\$	-	\$	\$	\$	\$
Titan Gray	-	-	\$	-	\$	\$	\$	-	-	-	\$	-	-	\$	\$
<b>Escluso con pred. 20 mm / Excluded with 20mm pred.</b>															
	\$	\$	\$	\$	\$	\$	\$	\$	\$	\$	\$	\$	\$	\$	\$

### INFORMAZIONI TECNICHE - TECHNICAL INFORMATION:

**WOOD:** Pannelli in nobilitato bifacciale ignifugo classe 0 / Fireproof bifacial chipboard melamine panels - Class 0

**SKIN:** Pannelli sandwich in lamiera plastificata ignifughi classe 0 / Fireproof Skinplate sandwich panels - Class 0

**INOX:** Pannelli sandwich in lamiera di acciaio inox ignifughi classe 0 / Fireproof Inox sandwich panels - Class 0

**PVC:** Vinyl eterogeneo compatto - Trattamento superficiale TopClean™ PUR per eccellente resistenza all'improntabilità, all'abrasione e ai graffi  
Heterogeneous and compact Vinyl - TopClean™ PUR surface treatment: extreme resistance to indentation, abrasion and tearing.

**VERNICIATURA / PAINTING:** Tutte le nostre verniciature sono in polvere poliestere texture opache rif.to ISO 7253 (Cert. Ist. Masini n°1812-2007)  
All our painting are in matt textured powder ISO 7253 (Inst. Masini Cert. n°1812-2007)

**Vipal**  
ITALIAN LIFT FACTORY

Tutti i diritti sono riservati. È vietata la riproduzione o divulgazione, anche parziale, del presente documento senza il consenso scritto della Vipal S.p.A.

Tutti i prodotti e le immagini sono inserite a scopo illustrativo e possono subire modifiche senza preavviso.

All rights reserved. Unauthorised reproduction or disclosure of all or part of this document, without Vipal Spa's written consent is prohibited.

All products and pictures shown are for illustration purposes only and they may be changed without notice.

PR - FESR 2021-2027 - Priorità 1 - OS 1.3 - Azione 1.3.2 - Sostegno all'internazionalizzazione delle PMI - Avviso pubblico per la presentazione di progetti di internazionalizzazione delle PMI mediante la partecipazione a fiere internazionali che si svolgono dal 1 aprile 2025 al 31 marzo 2026

PR - ERDF 2021-2027 - Priority 1 - OS 1.3 - Action 1.3.2 - Support for the internationalization of SMEs - Public notice for the presentation of internationalization projects of SMEs through participation in international fairs which they take place from 1st April 2025 to 31 March 2026



PROGETTO REALIZZATO GRAZIE AI FONDI EUROPEI DELLA REGIONE UMBRIA



Commissario Straordinario  
Ricostruzione Sisma 2016  
Presidenza del Consiglio dei Ministri

*the next level  
of vertical  
mobility*

---

DISTRIBUTORE CERTIFICATO  
CERTIFICATED DISTRIBUTOR

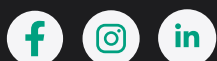
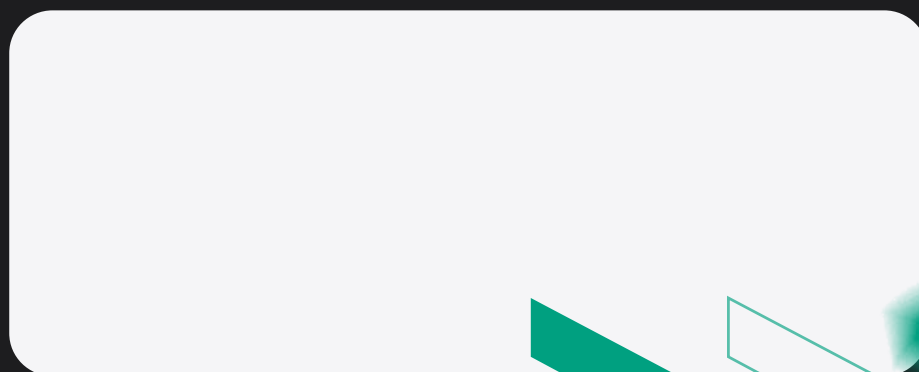

+39 0744 78 07 27

INFO@VIPALSPA.COM

VIA LUIGI EINAUDI, 1 - 05034 FERENTILLO (TERNI), ITALY



2025 REV.14